

Dane aktualne na dzień: 18-04-2026 09:28

Link do produktu: <https://multielektronik.pl/4010-p-4995.html>

4010

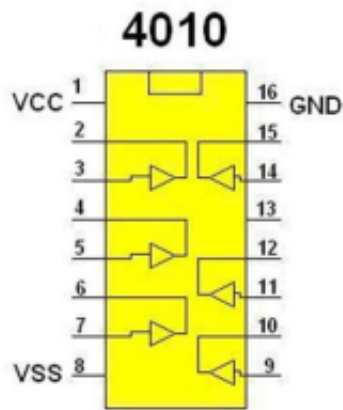

Cena	4,00 zł
Numer katalogowy	4010
Kod producenta	4010
Kod EAN	3004

Opis produktu

Układ scalony